

User Manual

Warranty (22~23)

SmartBidet™

SB-100R Electronic Seat

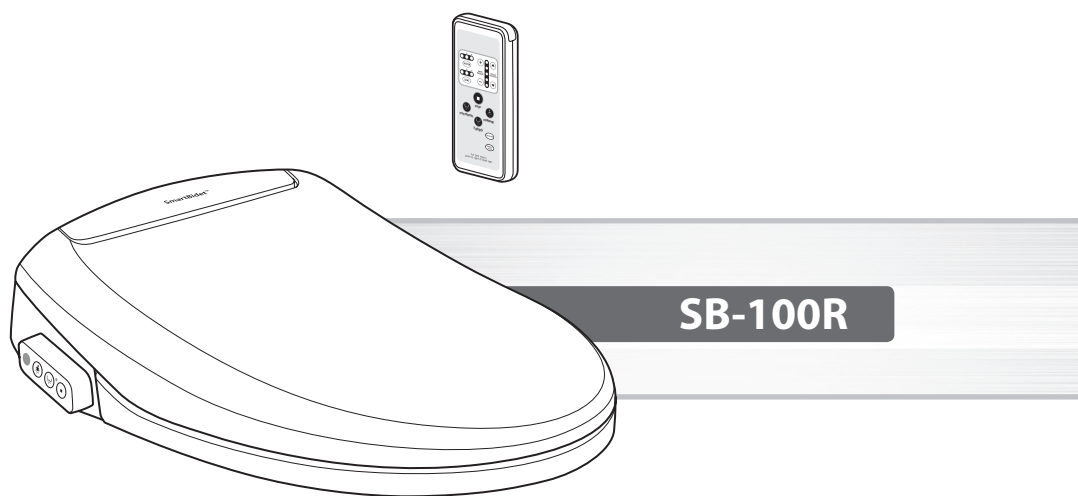

“Important safeguards/general cautions” are information that can protect the user from safety hazards and also prevent losses. Please be sure to read the manual correctly for proper usage.

- Please read the manual carefully before installation and utilization.
- This product is made for the US and Canada.
- The function and design of the product may be changed for quality improvements.

Important Functions



SB-100R
Distributed by Hitrons Solutions Inc









SmartBidet™

ELECTRONIC TOILET SEAT SIÈGE DE TOILETTE ÉLECTRONIQUE ASIENTO DE INODORO ELECTRÓNICO

Simply Clean. Stainless Nozzle.
Simplemente Limpia. Tout Simplement Propre.
Inoxidable Boquilla. Inoxydable Buse.

3-in-1 Improved Hygienic Functions
3-en-1 Funciones Mejoradas de Higiene
3-in-1 Amélioration des Fonctions D'hygiène

Revolutionary Heated Seat & Heated Water
Asiento Térmico Revolucionario y Agua calentada
Sièges Chauffants Révolutionnaire et Eau chauffée

 <p>Heated Water Eau chaude Agua caliente</p>	 <p>Adjustable Nozzle Bec réglable Boquilla ajustable</p>	 <p>Heated Seat Siège chauffant Asiento calefaccionado</p>	 <p>Easy to Use Facile a utiliser Facil de Usar</p>
 <p>Soft Closing Fermeture en douceur Cierre suave</p>	 <p>Stable seat Asiento estable Siège stable</p>	 <p>DIY Easy Installation Instalación fácil de DIY Installation facile de bricolage</p>	 <p>Replaceable Nozzle A buse remplaçable A boquilla reemplazable A</p>

Contents

Preparation	IMPORTANT SAFEGUARDS 4 General cautions 6 Product structure and designations (Product components) 8 Control designations 9
Operation & Cleaning	Installation and cautions 10 Initial operation 12 Separation of the unit from toilet bowl 13 Basic operation 14 Detailed operation 15 Maintenance 18 Draining water 19 Winter usage 19
Others	Troubleshooting 20 Specifications 21 Warranty 22-23

1 IMPORTANT SAFEGUARDS

• READ ALL INSTRUCTIONS BEFORE INSTALLATION AND USE



DANGER - To reduce the risk of electrocution:

1. Do not place or store product where it can fall or be pulled into a tub or sink.
2. Do not place in or drop into water or other liquid.
3. Do not reach for a product that has fallen into water.
If this happens unplug the unit and then remove item from water immediately.



WARNING - To reduce the risk of burns, electrocution, fire, or injury to persons.

1. Close supervision is necessary when this product is used by, on, or near children or invalids.
2. Use this product only for its intended use as described in this manual.
Do not use attachments not recommended by the manufacturer.
3. Never operate this product if it has a damaged cord or plug or if it is not working properly,
if it has been dropped or damaged, or dropped into water. Return the product to a service center for
examination and repair.
4. Keep the cord away from heated surfaces.
5. Never block the air openings of the product or place it on a soft surface, such as a bed or couch,
where the air openings may be blocked. Keep the air openings free of lint, hair, and the like.
6. Do not use the unit if you are sleeping or tired to the point of being drowsy.
7. Never drop or insert any object into any opening or hose.
8. Do not use outdoors or operate where aerosol (spray) products are being used or when oxidated products
are being administered.
9. Unplug this product before filling. Fill (reservoir) with water. Do not overfill (or specify filling instructions)

SAVE THESE INSTRUCTIONS

2 Cautions Before Installation

WIRING REQUIREMENT

THIS PRODUCT MUST BE PLUGGED into a regular voltage Grounded GFCI outlet (North America 120V AC, 60Hz). The rated power consumption is 660W / 600-700W. In locations where only a standard two-prong outlet is available, it is the responsibility of the user to install a grounded three-prong outlet. Using higher voltage is dangerous and may result in a fire or other accident. This product is not responsible for damage resulting from the use of it on other than specified voltage, or operating it without proper grounding.



WARNING

This Product must be on a separated circuit. No other appliance should share the circuit with this product.

Sharing a circuit could cause the branch circuit fuse to blow or the circuit breaker to trip. Continuous usage under these conditions may result in fire or property damage.

GROUND INSTRUCTIONS

This appliance has to be grounded.

This product has to be grounded. In the event of an electrical short circuit, grounding reduces the risk of electric shock by providing an escape wire for the electric current. This product is equipped with a cord having a grounding wire with a grounding plug. The plug must be plugged into an outlet that is properly installed and grounded.

Danger - Improper use of the grounding plug can result in a risk of electric shock.

If repair or replacement of the cord or plug is necessary, do not connect the grounding wire to either flat blade terminal.

Consult with a licensed electrician if you have concerns about whether the product is properly grounded.

This product is for use on a normal 120 V circuit, and has a grounding plug that looks like the plug illustrated in sketch A in Figure 1. A temporary adapter, which looks like the adapter illustrated in sketches B and C, may be used to connect this plug to a 2-pole receptacle as shown in sketch B if a properly grounded outlet is not available. The temporary adapter should be plugged into a properly grounded outlet (sketch A) and should be installed by a licensed electrician.

The green colored rigid ear, lug, and the ike extending from the adapter must be connected to a permanent ground such as a properly grounded outlet box cover.

Whenever the adapter is used, it must be held in place by the screw.

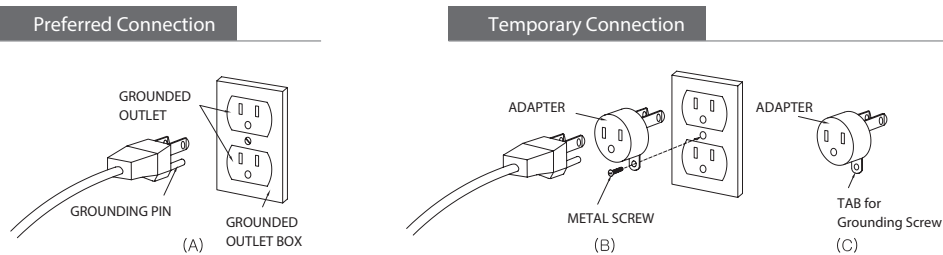

- Figure 1 -



DANGER

IMPROPER GROUNDING CAN RESULT IN A RISK OF ELECTRIC SHOCK.

Electric wiring has to be done in accordance with all local codes, or in the absence of local codes, with National Electrical Codes.

The use of an extension cord is not recommended or advised. If it is necessary to use an extension cord, use only a three-prong extension cord (one to one), and a three slot built-in GFCI receptacle that will accept the plug on this product. The marked rating of the extension cord should be equal to or greater than the electrical rating of the unit (10amp). Consult a licensed electrician if you are not sure whether the unit is properly grounded.

WIRING REQUIREMENT

- Instruction and caution statements for cleaning, user maintenance, operations recommended by the manufacturer, such as lubrication or nonlubrication, and a warning to the user that any other servicing should be performed by an authorized service representative or that the product has no user serviceable parts.

3 General Caution

Warning



Disassembling
remodeling prohibited

Do not separate, disassemble, repair or remodel the unit, or allow foreign substances inside the unit.

- This can cause a fire or electric shock.
- Only qualified service personnel should repair this product.



Do not spray water

Do not splash water on the main unit or power cord, and do not utilize it in areas of high levels of humidity.

- This can cause a fire or electric shock.



Grounding

This product must be grounded before usage and plugged into an AC 120V/60Hz power outlet.

- If grounding is not done, it can cause fire or electric shock.



Wet hands prohibited

Do not touch the power cord with wet hands.

- Do not plug or unplug the power cord with wet hands as it can cause electric shock or bodily injury.

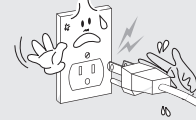

Prohibited

Do not supply electrical power to the product until it is installed on the toilet and the water supply hose is properly connected.

- This can cause a fire or damage the product.



Prohibited

Do not connect several power cords into one outlet.

- This unit uses 120V power outlet.
- Can cause overheating or fire hazards.
- Plug in the power cord properly into the power outlet.



Observe at all times

Please use public water supply.
Please do not connect the unit to industrial water or greywater.

- This can cause skin infections or urinary tract infections and also damage the unit.

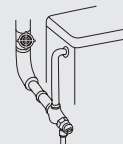

Use of fire prohibited

Keep the cord away from cigarettes or flammable substances.

- This can cause electric shock or bodily injury.





Unplugging the power cord

For safety purposes, unplug the power cord either when cleaning the product or detaching the unit from the toilet bowl.

- Failure to do so can cause an electric shock.

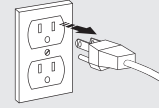

Observe at all times

Do not use a damaged power cord or a loosely fitted electric outlet.

- This can cause an electric shock.

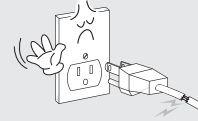

Prohibited

- Children, elderly, patients and those who are physically limited should use the low temperature setting for the seat, water and dryer.
- After using the unit at high temperatures, the temperature should be readjusted to 'low' for the elderly, children and for those with sensitive skin.
- Those who cannot adjust the temperature or those who have sensitive skin should take special precautions.



Prohibited

When cleaning, do not use cleaning detergents (**oxidized products, sink products, toilet cleaning products, and any types of stain removers**) on the external surface of the electronic toilet seat, do not spray air fresheners or aromatic products onto seat in attempts to eliminate odors.

- Using cleaning detergents or air fresheners can change the color of the external surface and can also cause problems with the seats functioning

Cautions



Prohibited

Do not stand on top of the seat cover, seat or main body unit. This can damage or break the unit.



Prohibited

- Do not use a broken product.
- As the unit is a bathroom appliance, do not use it for any other purposes.



Prohibited

Do not slam or close the seat or seat cover forcefully.



Prohibited

Prevent children from putting foreign substances or inserting their hands into the dryer outlet or onto the nozzle.



Prohibited

Do not pull the connecting hose forcefully or bend it.

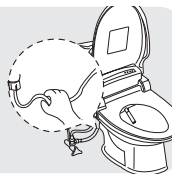

Prohibited

Never put the product in water.



Observe at all times

Do not let urine contact the dryer outlet or nozzle area.



Observe at all times

When cleaning or not using the product over a long period of time, be sure to unplug the unit.



When the following people sit down on the seat, a guardian should pay extra attention so that they will not fall when sitting on the toilet seat or standing up from it.

- Children, elderly, or those who cannot independently sit or stand on the seat.

4 Product structure and designations

Main unit

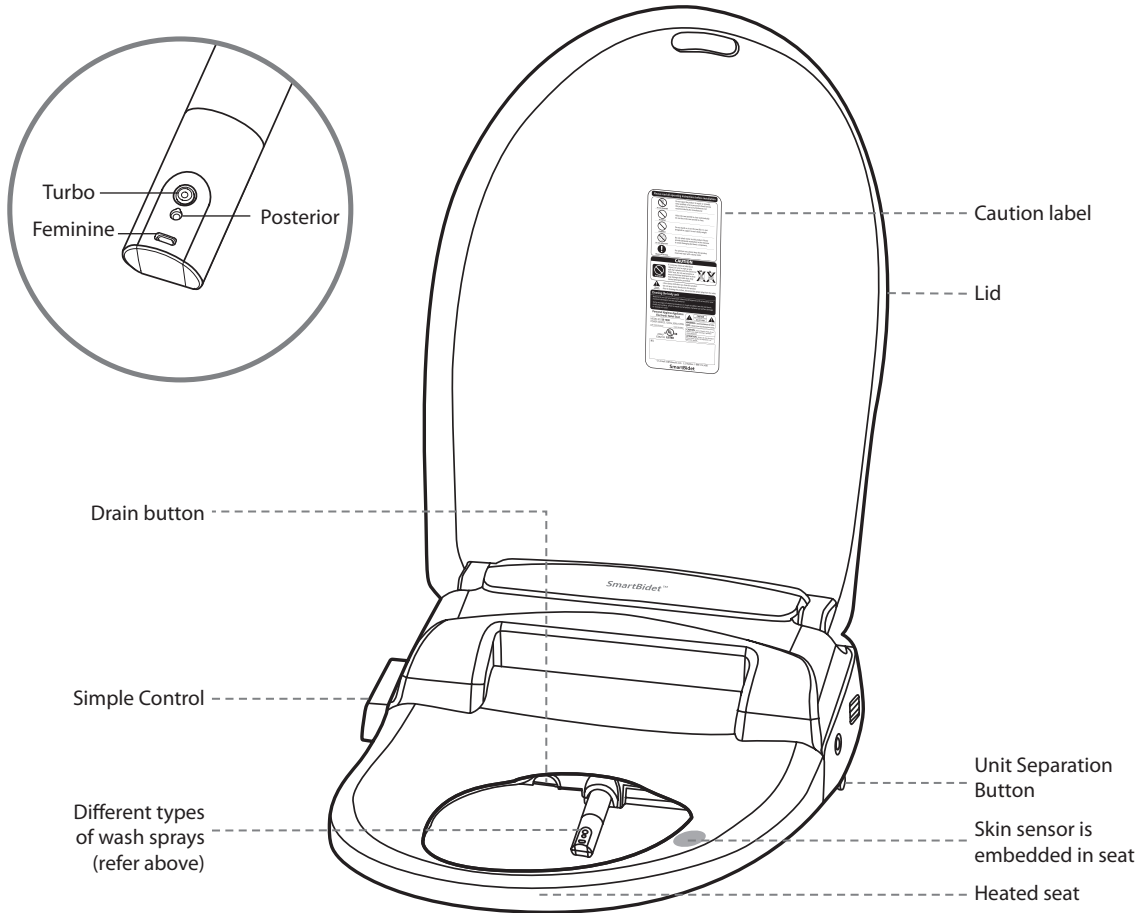

Product components









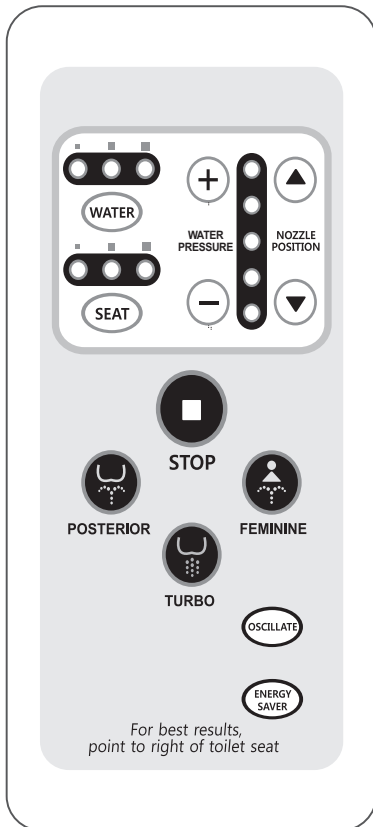

For plumbing	For product fixation	For remote control	Installation instructions
<p>T-Valve & packing Conversion Nut</p>	<p>Cone packing (2pcs) Nuts (2pcs) Bolt Case (2pcs)</p>	<p>Remote control Remote control holder</p>	<p>User manual</p>
<p>Water supply hose (for electrical toilet seat)</p> <p>Water supply hose (for toilet flush water tank)</p>	<p>Mounting bolts (2pcs) Base Plate (1pcs)</p>	<p>1.5V AAA type Battery (2pcs)</p>	

Remote Control

Caution

If the remote control is not used for 10 seconds, the LED light will turn off automatically to protect its battery life.



	STOP	Stop
	TURBO	For His Back Wash
	FEMININE	For Her Front Wash
	POSTERIOR	For Her Back Wash
	OSCILLATE	During a wash, if you press on this button, the nozzle will oscillate back and forth for a wider wash. Pressing it once more will stop the oscillation.
	ENERGY SAVER	Pressing this button On or Off with activate or deactivate the Energy Saving mode.
	WATER PRESSURE	The water pressure can be adjusted up to 5 levels.
	NOZZLE POSITION	The oscillating mode and nozzle position can be adjusted up to 5 levels.
	WATER	The water temperature can be adjusted up to 4 levels.
	SEAT	The seat's temperature can be adjusted up to 4 levels.

- Always sit on the middle of the unit and do not sit on the side of the seat.
(The basic functions will not work if the skin sensor is not active.)
- When operating For POSTERIOR/FEMININE/TURBO, if the water temperature is low and cold water comes out after using it for a period of time, pause and wait for 3 minutes for warm water to be provided.



Sitting on the heated seat or using the dryer for an extended period of time can potentially cause low degree burning. Special precautions should be taken for children, those who cannot adjust the temperature, and those who have sensitive skin.

5 Installation

⚠ Caution

- This product requires 120V usage.
- Please do not plug in the electrical cord prior to installation.
- Please consult with a licensed electrician if electrical work is needed. In case a grounded outlet is not available, grounding should be done in order to prevent short circuits or electric shock.

Check the water valve

Check the water valve in the bathroom. You may need to consider purchasing additional components. For the following case, the T-valve alone is sufficient for connection.

• Water supply valve

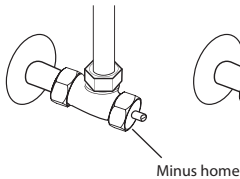

Minus home

• Inner bolt water valve

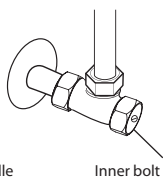

Handle

Inner bolt for water valve

• Professional engineering is needed for plumbing work on specialized water pipes and flush valve pipes.

- Please consult with a qualified specialist.
- Please put the unused water hose in a secure area.

Installation steps

1 Shut water supply by turning it to the right.

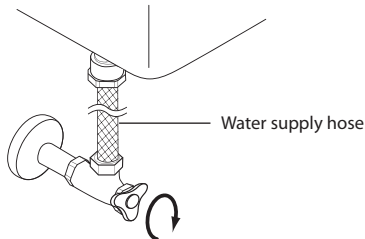

2 Disconnect existing hose from water tank. Connect the T-valve to the water tank.

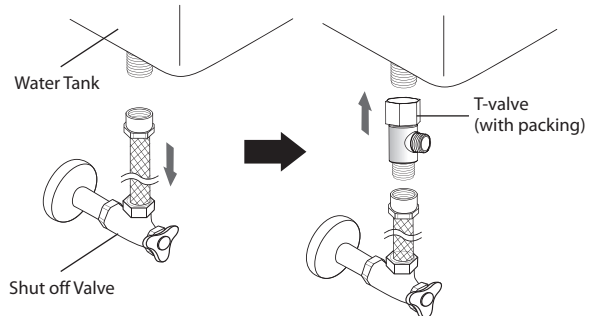

3 Connect the water supply hose to the assembled T-valve.

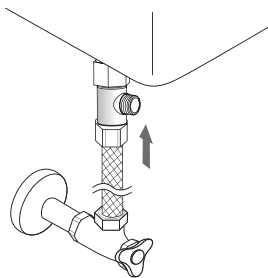

4 Remove existing seat and lid.

- Release the bolts on both sides of the existing toilet seat to remove the seat and lid.
- Store the removed seat, nut and water hose in a safe area in case you move or it needs to be reinstalled.

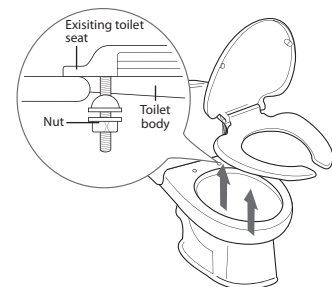

- 5** Place the bolt into the bolt case and align it with the top of the base plate. Insert the bolt with bolt case onto the base plate. After this is done, hold the bolts, gently slide it into the bottom of the unit until it clicks in place. You will hear a click sound. Please do NOT use force.

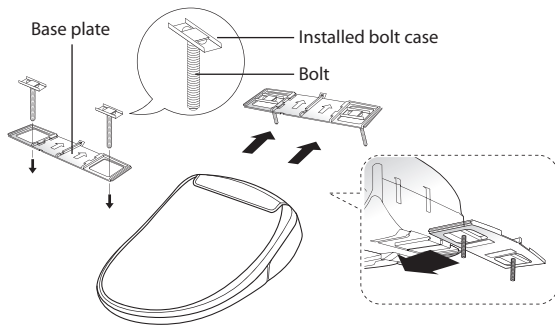

- 6** Install the main unit and insert the mounting bolts to the toilet mounting holes.

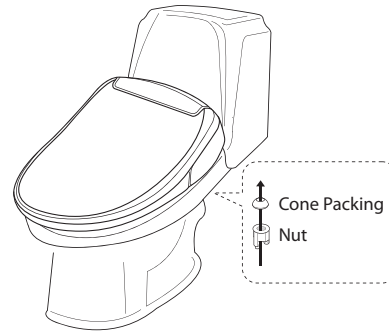

- 7** Once the base plate is attached to the unit, align the unit and toilet fixture facing front, and then insert the mounting bolts to the toilet mounting holes. Please do not over tighten the nut.

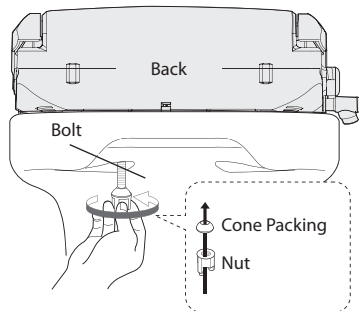

- 8** Connect the flexible tube from side of T-valve to the unit. Turn the water valve to the left to allow water to flow.

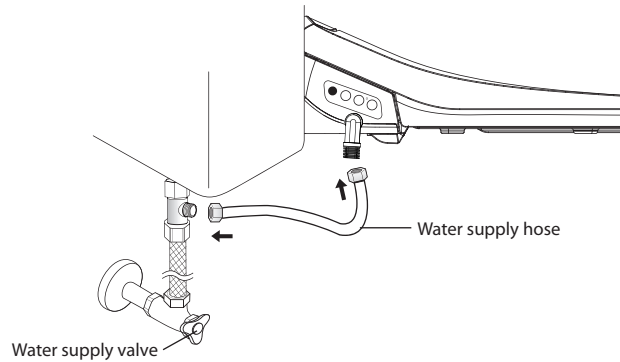



※ Customers should use the new hose set provided with the product. Do not use used set again.

6 Initial Operation

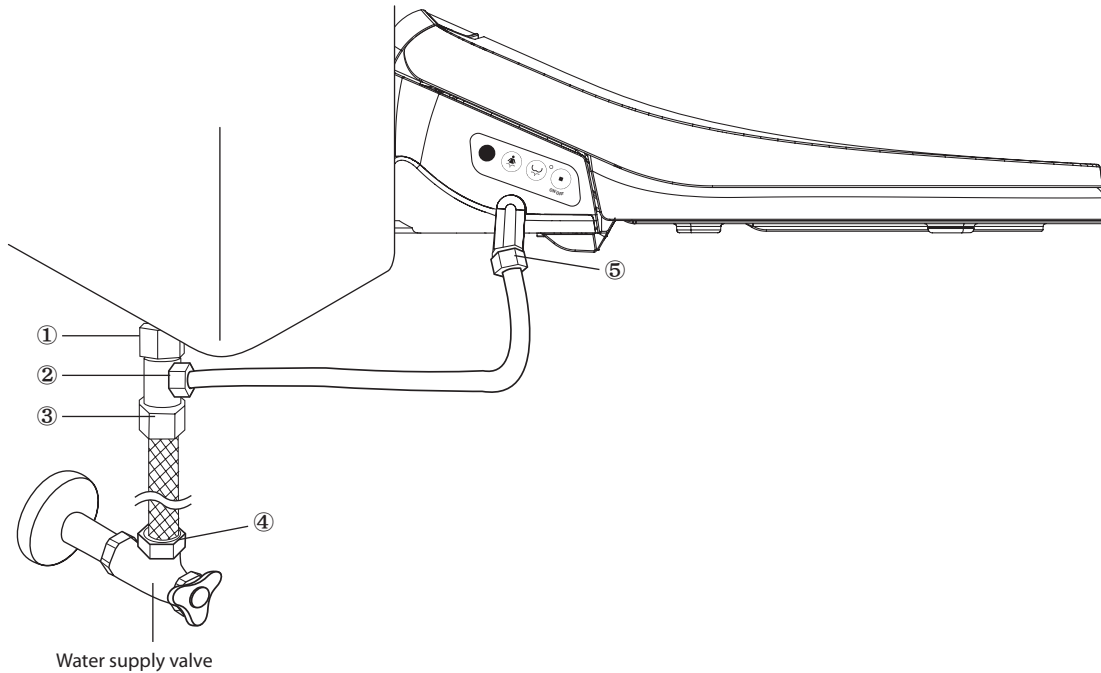
- 1 Turn the water supply valve to the left and see if there is any water leaking from the hose.(①~⑤)



- 2 Connect the power cord to the 120V electric outlet.
- 3 If you press  or  button on simple control, the water will begin to enter the heated water tank.
 - If the tank is full, then a low beeping sound will occur which indicates that preparation is complete.
- 4 Function Check
 - In order to check whether the functions work, you will first need to touch the seat or sit on it to activate the skin sensor.
 - Please be aware that water will come out. This product can only operate when the user sits on the electronic toilet seat.

7 Separation of unit from the toilet bowl

Please follow the instructions below when moving or separating the unit from the toilet for cleaning purposes

- 1 Disconnect the power plug
- 2 Shut the water supply valve
- 3 Push and hold the button on the left side of the unit to completely drain the water from the water tank.
- 4 Loosen the nut on the hose that is connected to the unit, and then separate the electronic toilet seat from the toilet in the following order as illustrated.

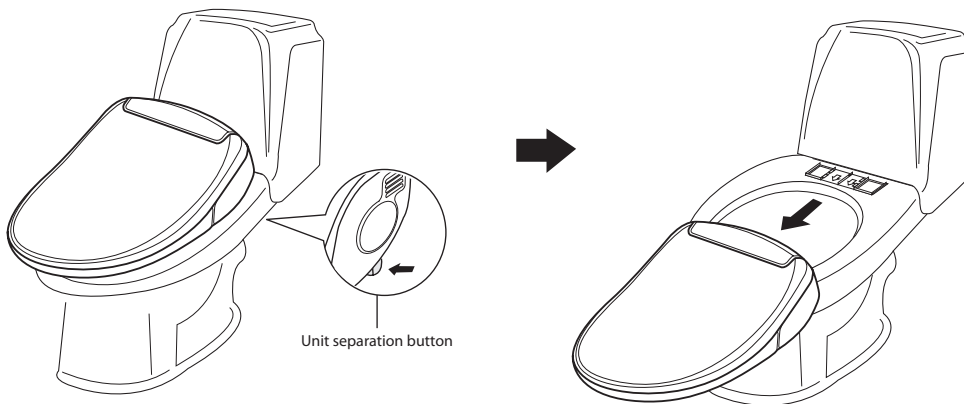
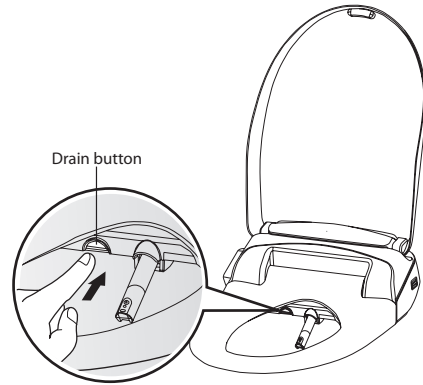

- 5 While pushing the button (area shown as an arrow) push the electronic toilet seat slightly toward to the front and then the body unit will begin to slide out. Next, lightly pull the unit toward the front and it will detach from the toilet.



Do not turn the seat upside-down. This can cause damage to the unit as well as fire hazard.

- 6 Disconnect the T-valve from the water tank.
- 7 Connect the water hose to the toilet which was disassembled while installing the electronic toilet seat, and turn the water valve to the left to open it. See if there is any leaking from the water hose connection.
- 8 Re-install the toilet seat and lid that was separated when installing the electronic toilet seat.
 - As explained above, steps 1~4 are instructions for separation of the unit for basic cleaning purposes, and steps 5~7 are instructions for separation when moving, etc.



Operation (Basic)



Caution



Cautions

Please press the 'off' or 'low' button for seat temperature when the following persons use it. Special precautions should be taken for children, those who cannot adjust the temperature, and those who have sensitive skin.

Sit on the seat.

- Sit on the toilet seat so that the skin sensor can fully be activated.

Warning

- Do not press the control buttons harder than needed. This can cause damage.
- The skin sensor of the seat is only activated with bodily contact, please be sure to pull down your clothes amply and do not cover the seat with any clothing items, as it can prevent the seat from activating.

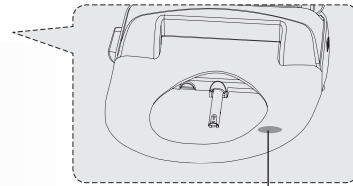

Skin sensor

Please press  or , 

- Wash is available Posterior, Feminine and Turbo.
- The selected function can be used for up to 1 minute.

Warning

- The wash functions will automatically stop after one minute. If you want to use it continuously press the button again.

Press 

- To Stop POSTERIOR, FEMININE, TURBO Wash.

9 Operation (Instructions to operate each function)

Water pressure

- Press \oplus (high), \ominus (low) for the Water (Water pressure can be adjusted 1~5 levels.)
- It is recommended that the water filter (strainer) is cleaned periodically, as water pressure can be weakened if foreign substances cling onto the water filter (strainer).
- LED level

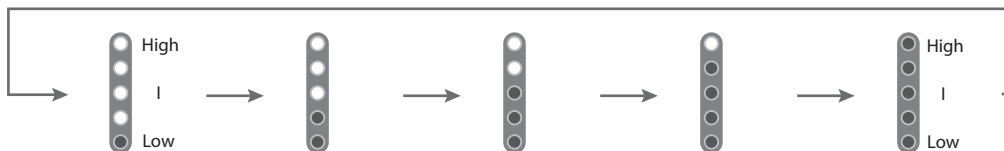

- To increase water pressure press \oplus (high) on the remote.
- To decrease water pressure press \ominus (low) on the remote.
- As the water pressure increases the LED lights will illuminate the levels(see above illustration).

Water temperature adjustment

- When pressing WATER button the display light() will change to allow the adjustment of the water temperature to the desired level.
- Average maintenance time for warm water: This product can maintain the warm water level for up to 50 seconds during a 1 minute wash session.

Water temperature

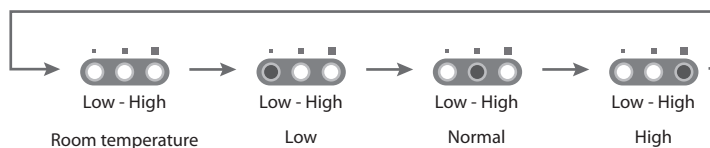
Low - High



Seat temperature

- When pressing SEAT button display light() will change. Temperature can be adjusted to the desired level.

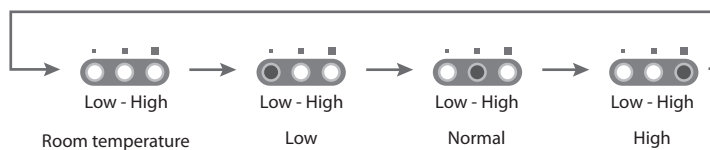
Seat temperature

Low - High



9 Operation (Instructions to operate each function)

Nozzle position adjustment

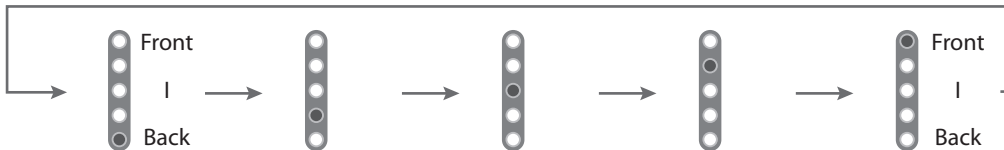
- When using the wash functions use ▲(front), ▼(back) buttons to adjust the nozzle to fit to your body.
- LED level



Oscillate



- After pressing one of the wash functions: FEMININE / POSTERIOR / TURBO, pressing oscillate button will activate the oscillating nozzle, covering a wider area of washing.
- Press the STOP button to stop the oscillation.

Automatic self cleaning nozzle

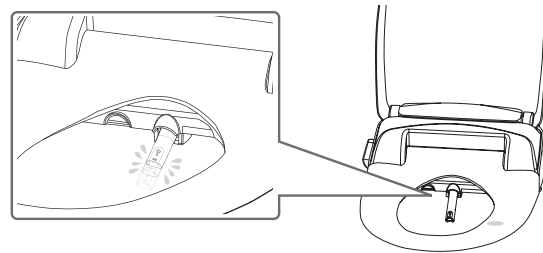
- Before and after using FEMININE, POSTERIOR, TURBO the nozzle will automatically clean itself.



Energy saver

- When pressing  the energy saver light on the electronic toilet seat will turn on.
- Energy saver mode automatically maintains a water and seat temperature of 89.6 F°.
- If you want to turn off the energy saver function, press the  button again and the display light will turn off.



During a power outage, the water or seat heating temperature could appear to be lower than the actual temperature setting.

Other energy saving tips

In order to save energy, please abide by the following instructions:

- Keep seat cover closed when not in use to prevent heat from being lost.
- Keep temperature set to low.
- Unplug the power cord if you do not plan to use it for a long period of time.

Setting up and using the remote control

- Select a convenient spot near the toilet to attach the remote control holder
- Make sure that the selected spot will not be exposed to water and the area where you intend to affix the holder is clean and dry
- Remove film from the double sided tape located on the back of the remote control holder and place the holder in the selected area.
- On remote control insert the two(2) batteries (1.5V AAA) ensuring that the poles on the batteries correspond to the directions on the remote control.

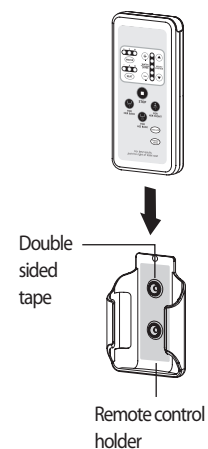
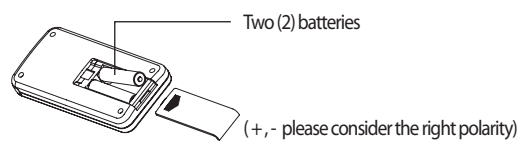

- Always purchase the correct size and grade of battery most suitable for the intended use.
- Clean the battery contacts and also those of the device prior to battery installation.
- Remove batteries from equipment which is not to be used for an extended period of time.
- Remove and replace all batteries.

10 Maintenance

Cleaning the body unit

- Beware to not use any bathroom cleaning detergents such as benzene acid chemical detergent on the seat exterior.
 - Using any type of chemical products or rough scrubbers on the electronic toilet seat surface, which is made out of plastic material can either damage or change its color.
- Do not spray water directly or use a shower hose on the main body unit.
 - Can cause fire or damage to the unit.
- When cleaning, the power cord must be unplugged from the power outlet, and make sure water does not contact the cord and/or outlet.
- After cleaning, use a soft cloth to dry the unit.



Do not use cleaning products non chemical detergent. We recommend to mix baking powder and water or vinegar and water to clean the unit.

Cleaning the nozzle

- Please perform the actions below without sitting on the toilet seat
 - On Simple control press and hold the 'POSTERIOR' button for three (3) seconds and the water nozzle will extend.
 - To clean use a soft bristled brush (tooth brush) or a soft cloth. Upon completion press and hold the 'STOP' button and the nozzle will retract back to its original position and will perform its self-cleaning function.
 - Upon completion of these two steps the toilet seat can be used.

Cleaning the water filter (strainer)

- 1) Close the water shut off valve.
- 2) Flush the toilet to empty the water reservoir.
- 3) Unscrew the water hose nut.
- 4) Clean the strainer with a small brush or water
- 5) Re-screw the water hose nut.
- 6) Open the water shut off valve.

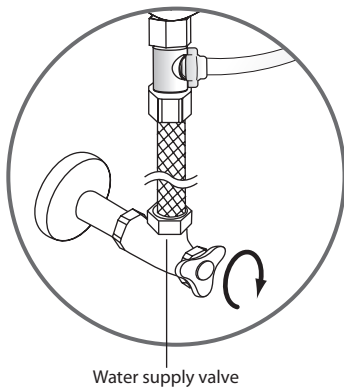

Water supply valve

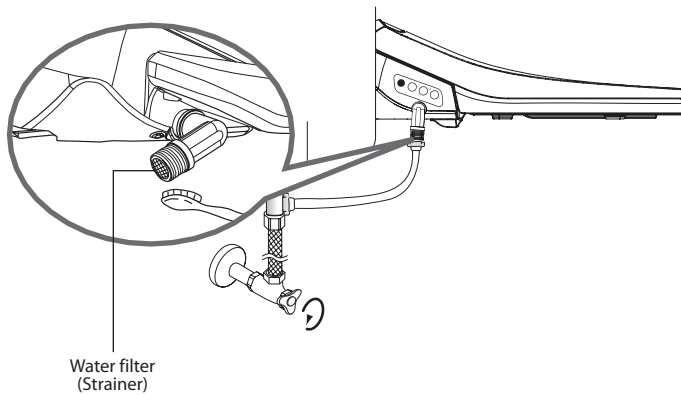

Water filter (Strainer)

11 Draining water from tank

- 1 Disconnect the power plug.
- 2 Shut the valve by turning it to the right.
- 3 Press the drain lever until the water is completely drained from water tank.
- 4 To re-supply water after draining, open the water shut off valve.

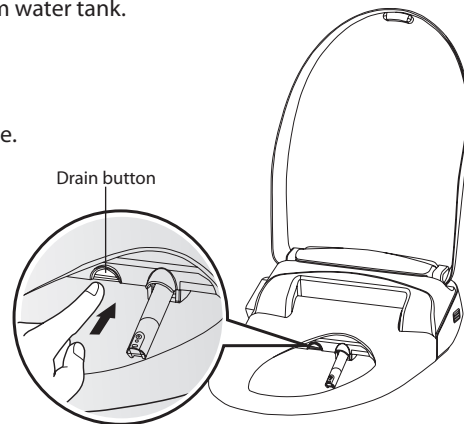

Do not drink the drained water.
Do not insert finger into the drain hole.
Before draining, unplug the power cord and wait 30 minutes until the unit has cooled down.

12 Maintenance for winter season

- 1 Check if the power cord is plugged in securely.
- 2 Adjust the  button to "low" to prevent water from freezing.
- 3 If the product is not used for a long period of time, especially in cold regions or environments, please disconnect the power cord and drain the water from the internal unit.
- 4 Please do not keep this product outdoors during the winter as the cold temperature may damage the product.



13 Troubleshooting

• Please be sure to check the following aspects before asking for help.

Troubleshooting	Factors to check
The water does not spray	<ul style="list-style-type: none"> • Check if the water tank is filled. (If the water tank is filled, water is supposed to come out when push the unit separation button.) • See if the water valve is closed. • Check if the water filter (strainer) is clogged. If it is clogged, please clean it referring to page 18.
The unit is not operating	<ul style="list-style-type: none"> • Check if the power cord is connected. • See if the power is turned off from the main unit. (If the power is turned on, the red light on the black panel is supposed to be turned on.) • See if you are correctly sitting on the seat so that the skin sensor switch will function properly. (Make sure that the Skin sensor on the seat touches your skin when you sit on the seat.)
Water is leaking	<ul style="list-style-type: none"> • Check the plumbing is correctly connected. If water is leaking from the main unit, shut off the water valve first and disconnect the main unit. Then, contact service personnel.
Water pressure is weak	<ul style="list-style-type: none"> • Check if the water pressure is set at "low". • Check if the water filter (strainer) is clogged.
Seat, water is not warm	<ul style="list-style-type: none"> • See if the water temperature is set to "low". • Check if the energy saver mode is on. If it is on, seat and water temperature are maintained at 89.6 °F.
When the nozzle doesn't come out	<ul style="list-style-type: none"> • See if the skin sensor on the seat is touching the skin. • Go to this link and follow the video : https://www.youtube.com/watch?v=0VaRF5FKIaM
When water is cold or warm	<ul style="list-style-type: none"> • Adjust the temperature to (mid, high). • If someone has already used the wash function, wait about 3 minutes to use it. • Sit on the seat for approximately 3 minutes and then use it.
Body unit shakes	<ul style="list-style-type: none"> • Tighten the bolt (do not over-tighten)

14 Specifications

Specification		SB-100R
Power rating		120 V / 60 Hz / 670 W
Water inlet type	Type	Direct Inlet Flow Type
	Water inlet pressure	0.07 ~ 0.74 MPa
Wash device	Posterior	Max. 700 cc ± 100 cc / min.
	Feminine	Max. 700 cc ± 100 cc / min.
	Turbo	Max. 700 cc ± 100 cc / min.
	Water pressure adjustments	5 levels
	Warm water temperature control	Room Temp. ~ Low, Normal, High
	Heater	600W
	Safety device	Thermal fuse, Thermal switch, Float switch
Heated seat	Temperature control	Room Temp. ~ Low, Normal, High
	Heater	55 W
	Safety device	Thermal fuse
Inlet water temperature		37.4 °F ~ 95 °F (3 °C ~ 35 °C)
Ambient temperature		37.4 °F ~ 104 °F (3 °C ~ 40 °C)
Dimensions		Elongated
		W : 15.4 inch (392 mm) L : 20 inch (508 mm) H : 6.06 inch (154 mm)
Weight (lbs)		9.4 lbs (Packed : 12.3 lbs)

- The design and function of this product could be changed without notice for the improvement of its quality.
- Weight capacity 440 (lbs).

Information to the user

This equipment has been tested and found to comply with the limits for a Class B digital device, pursuant to part 15 of the FCC Rules. These limits are designed to provide reasonable protection against harmful interference in a residential installation. This equipment generates, uses and can radiate radio frequency energy and, if not installed and used in accordance with the instructions, may cause harmful interference to radio communications. However, there is no guarantee that interference will not occur in a particular installation. If this equipment does cause harmful interference to radio or television reception, which can be determined by turning the equipment off and on, the user is encouraged to try to correct the interference by one more of the following measures:

- Reorient or relocate the receiving antenna.
- Increase the distance between the equipment and receiver.
- Connect the equipment into an outlet on a circuit different from that to which the receiver is connected.
- Consult the dealer or an experienced radio/TV technician for help.

WARNING

Any changes or modifications not expressly approved by the manufacturer could void the users authority to operate the equipment and limited warranty.

Warranty

Hitrons Solutions Inc. Limited Warranty

General Limited Warranty Covered **Hitrons Solutions Inc** will warrant to the original retail buyer only, which falls in normal user and within the applicable periods specified below. **Hitrons Solutions Inc** replacements will be warranted to the original purchaser of the products only.

The Parts Warranty if the parts fail within Twelve(12)months after original purchase from authorized retailer, following the installation manual and normal operation, **Hitrons Solutions Inc** will furnish replacement part(s) after warranty registration.

• **This Warranty does not cover the following**

1. Defects and/or malfunctions from failure to properly install, operate and/or maintain the unit in accordance with the installation manual.
2. Damage from abuse, fire, flood, freeze, and any other acts of Nature.
3. Damage resulting from unauthorized alterations, attachments and/or repairs.
4. If the product was not installed properly.
5. Damage to the unit by animals, mice or insects.
6. Damage caused by excess moisture or from water clogging the bathroom or restroom.
7. Damage from not being installed in accordance with all applicable local codes, ordinances and good trade practices.
8. Color fading due to use in wrong environment.
9. Damage from chemicals.
10. The warranty will not be covered without providing the date of purchase with original receipt.

WARRANTY REGISTRATION

To ensure your warranty protection, please access <https://smartbidet.net> and complete the registration or please send via email to cs@hitronsinc.com within 15 days after date of purchase to validate your warranty. If you choose to send through email, in the Subject line, please write "Warranty Registration - SmartBidet Model: _____ Serial number: _____ & PO: _____."

Model _____ *** Serial Number #** _____

Customer

Name _____

First & Last Name _____

Shipping Address _____

City _____ Country _____

Email _____ Phone Number _____

Retailer

Name of Retailer _____ PO Number _____

Attn: Warranty Dept.
Hitrons Solutions Inc.
cs@hitronsinc.com

Service Department
Hitrons Solutions Inc.
Inquiries and Support
Email : cs@hitronsinc.com
Phone : 1-800-515-3430

* The serial number is located under the lid of the SmartBidet.



SmartBidet™

Electronic Bidet Seat

Service Department

Hitrons Solutions Inc.

Inquiries and Support

Email : cs@hitronsinc.com

88 Portland Avenue, Suite M

Bergenfield, NJ 07621

Phone : 1-800-515-3430

2018 SEP 1.0